



EWA
هيئة الكهرباء والماء
Electricity & Water Authority

Manual for Premises Internal Plumbing Network

Electricity and Water Conservation
Directorate



Preamble

Water leaks are one of the most important issues that concerns us and the customers. Leaks from pipes, plumbing fixtures and fittings are a significant source of water waste for many premises. Some leaks are visible; such as dripping faucet, while others are invisible (e.g. buried pipes). These leaks are often the cause of serious structural problems as well as many health risks associated with living or working in a damp property.



Symptoms of water leaks are identified below and are attributed to plumbing issues. To minimize these risks of water leaks, we are presenting this manual which highlights the building terms and conditions and illustrates the implementation of internal plumbing networks according to the requirements set by Electricity and Water Authority (EWA).

The consequences of water leaks

Damages and risks which are attributed to water leaks are summarized as follows:

- High monthly bills.
- Water shortage at the premise.
- Health problems for residents as a result of the growth of molds, funguses and algae.
- Cracks in walls, ceilings, floors and foundations.
- Power cuts and high damage on electrical switches and appliances.
- High expenses incurred in repairing the damages.
- Stains, discoloration and streaks all over the walls and ceilings.
- Exterior and interior paint damage.

1. Electricity & Water Conservation Directorate

Water Conservation Section

1.1. Internal Plumbing Requirements

The water network for premises must be in line with “Bahrain Water Regulation System” requirements as follows:

- Ground Tank inlet level at a height of one meter (1 m) above the street level, and not more than thirty meter (30m) distance from the main meter.

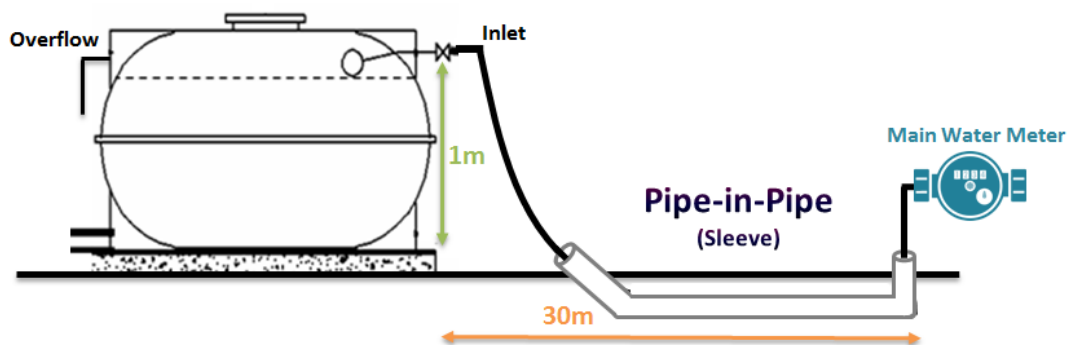
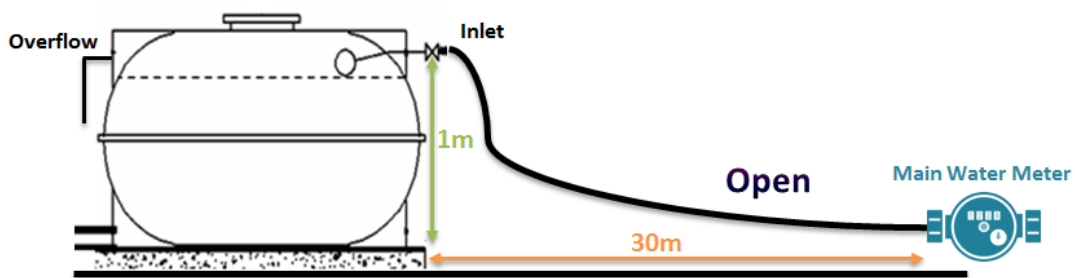

- All storage tanks should be accessible, white colour and under shade to avoid direct sun rays.

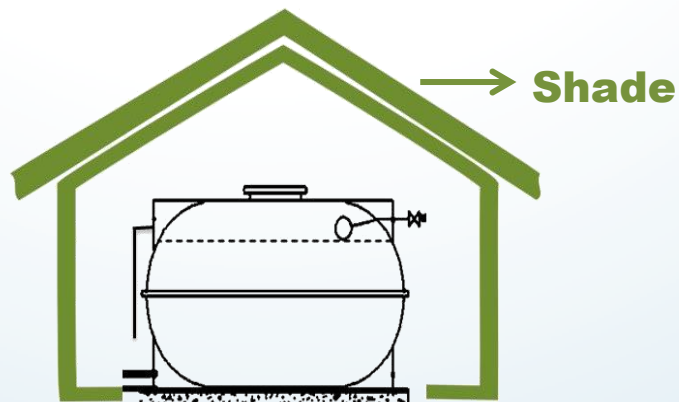

- The ground water tank overflow line should be installed below the water inlet line by (3 – 5 cm).

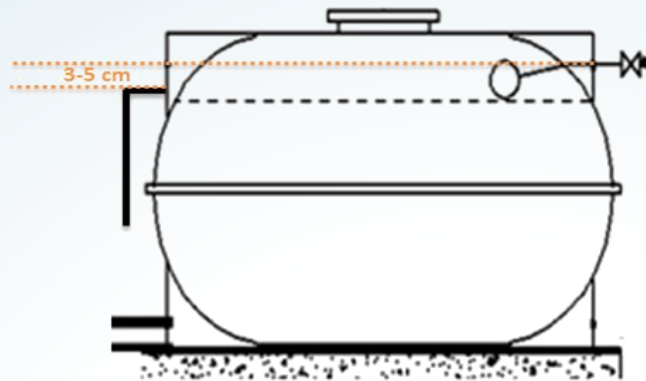

- An alarm system, which is either audible or visual, should be fixed in all underground or ground water tanks with a capacity of more than 10 m³. The alarm system should be activated when the water level reaches 50mm below the water tank inlet.

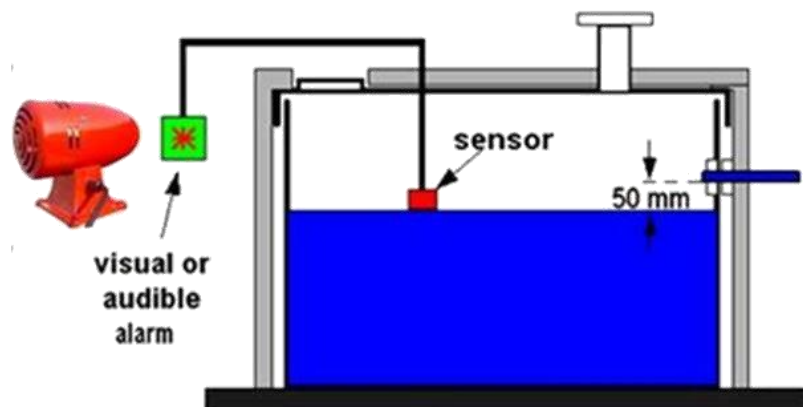

- Overflow water pipes should not be connected to the drainage, they must be in a visible location, where the discharge of water can be seen or noticed.

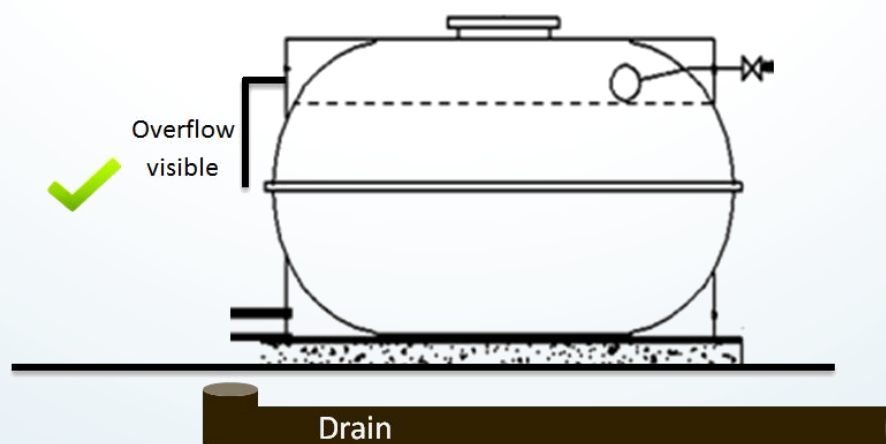

- All water pipelines in the internal network should be open or installed in a sleeve (Pipe-in-Pipe) to facilitate easy repairing or replacing in case of water leaks.

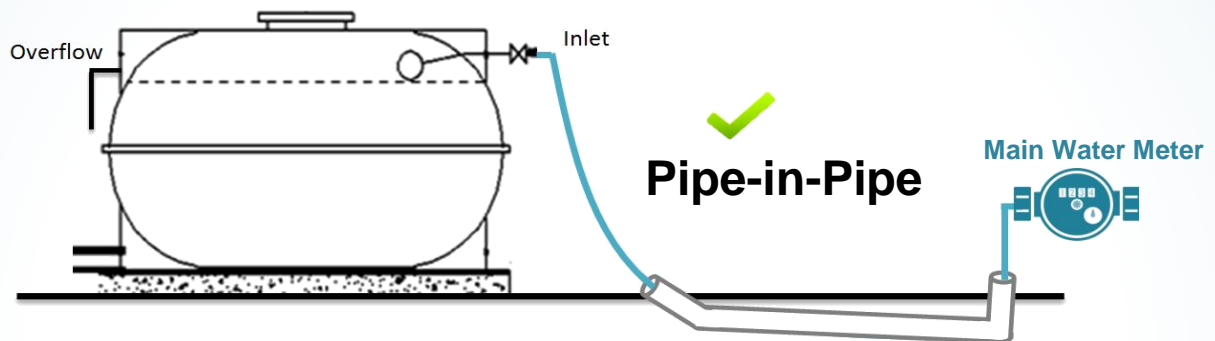
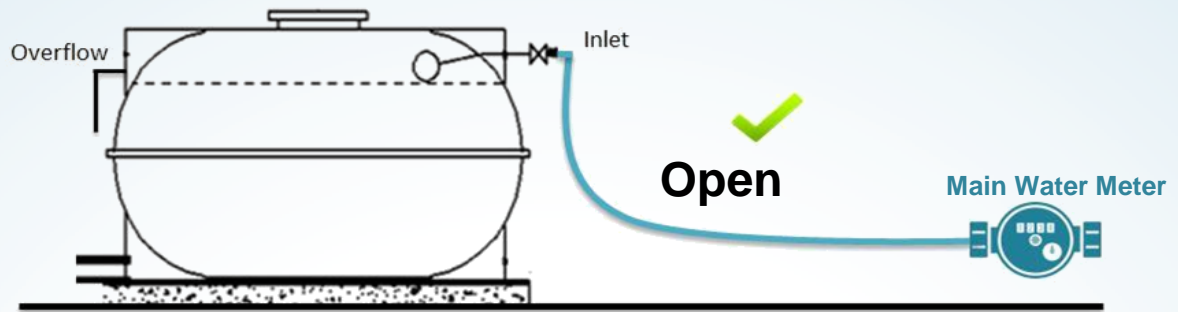

- Isolating valves must be installed on all water lines supplying all the utilities of the premises.



- Safety valves should be installed in all water heaters. Hot and cold pipes should be thermally insulated. It is preferable to shorten the water pipe distance between the faucets and the water heater.

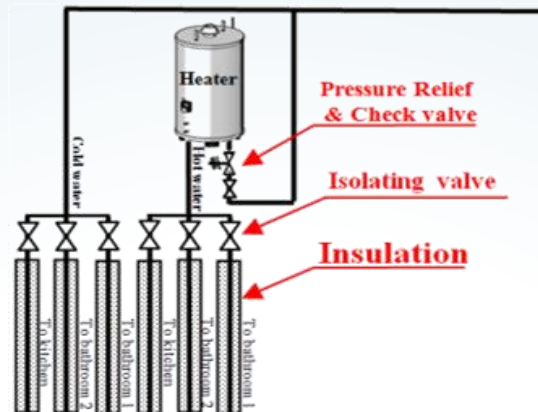

- No illegal connection or direct pumping & intakes from the supply line.

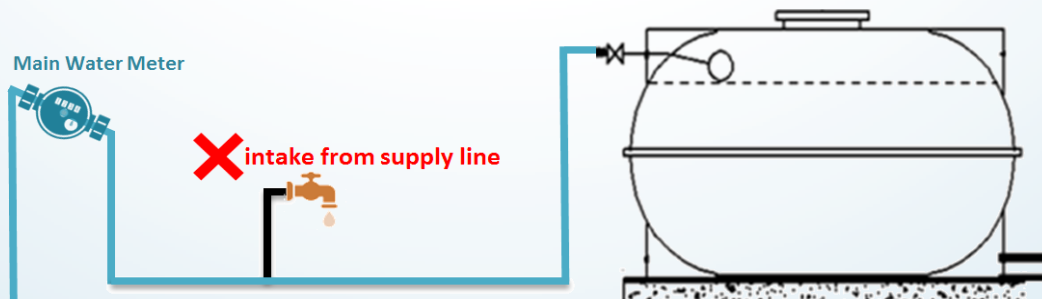
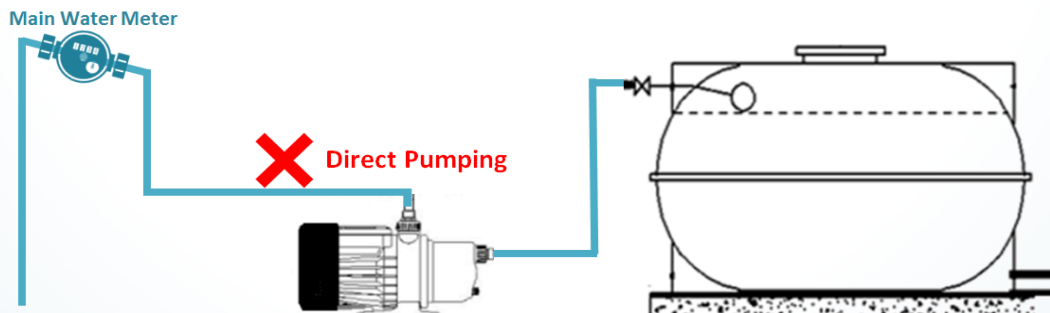
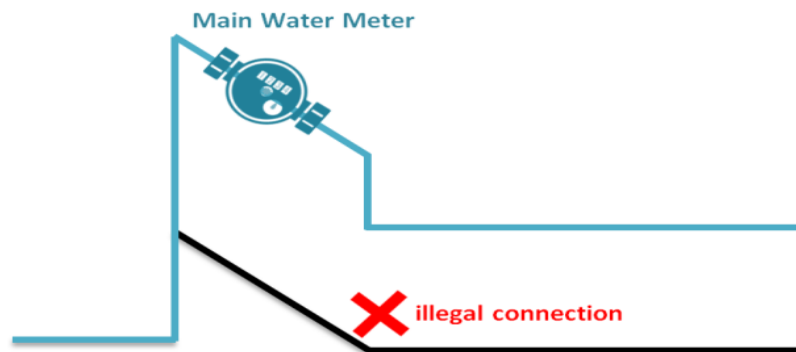

- The internal pipe lines in the network have to be hydraulically tested for 24 hours with a pressure of 150% times the internal pressure to ensure there is no leakage in the system.



1.2. Water Appliances Requirements

- Automatic sensor type mixers in public places must be considered.
- It is advisable to use single-arm mixers (single lever) in normal domestic toilets.



Single "lever" type



Automatic sensor type

- Urinals should be flushed only after use either manually or by electronic sensor.



Sensor Type



Press Type





- The volume of the flush tank should not exceed 6 litres with a dual-flushing mechanism and an isolating valve installed before the flush tank.

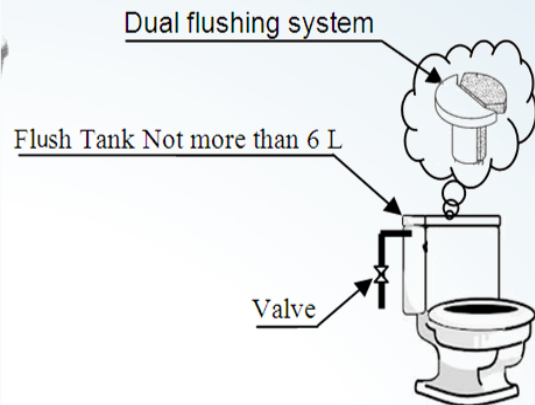

Dual Flushing Mechanism

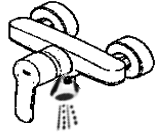

- Flow rate should not exceed the following values:

Fitting		Maximum Flow at outlet (Litres/minutes)
Sink Basin / Bib Tap		10
Wash Basin Tap		8
Bath Tap		12
Shower Tap		10

1.3. Garden Requirements

- The agriculture tank inlet has to be higher than the main inlet of ground storage tank by 0.5m.
- Modern Irrigation Systems (Drippings or Sprinklers with timers) should be provided in gardens.
- Garden tap size should be 1/2" diameter.

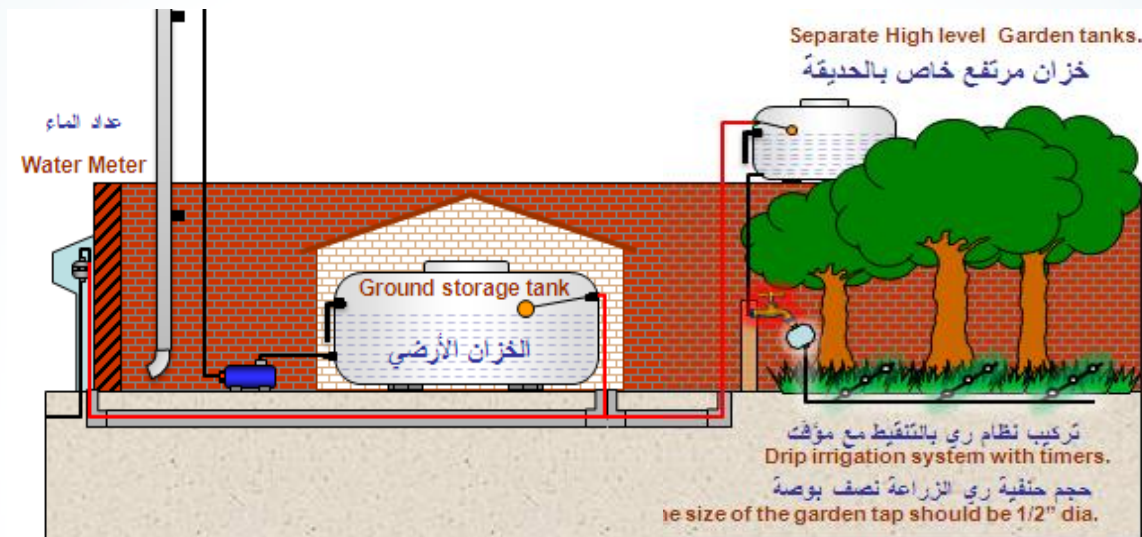

- All lines used for sprinklers, must be well routed and as much as possible, run through a sleeve to detect any leakage.
- Gardens should be provided with modern irrigation systems such as Dripping or Sprinklers and include a timer with adjustable timings for early morning, or evening time.
- Set the timers to run between 20 - 30 minutes, twice a day; early morning and late evening.
- Lawn areas should be restricted in size to avoid high water consumption.



2. Water Distribution Directorate

Water Meter Installations:

There are different types of arrangements for Water Meter Installation according to the type of premises and the number of meters:

2.1. Premises with Boundary Wall

- The standard size of water meter connection is (15mm).
- Cavity type to be installed on the permanent boundary wall.
- The customer shall construct part of the boundary wall including the cavity for the water meter as approved sizes and measures. (A minimum width of 1.50m).
- There are two types of cavity meter arrangements which are illustrated as follows:

A. Cavity Loop-Out

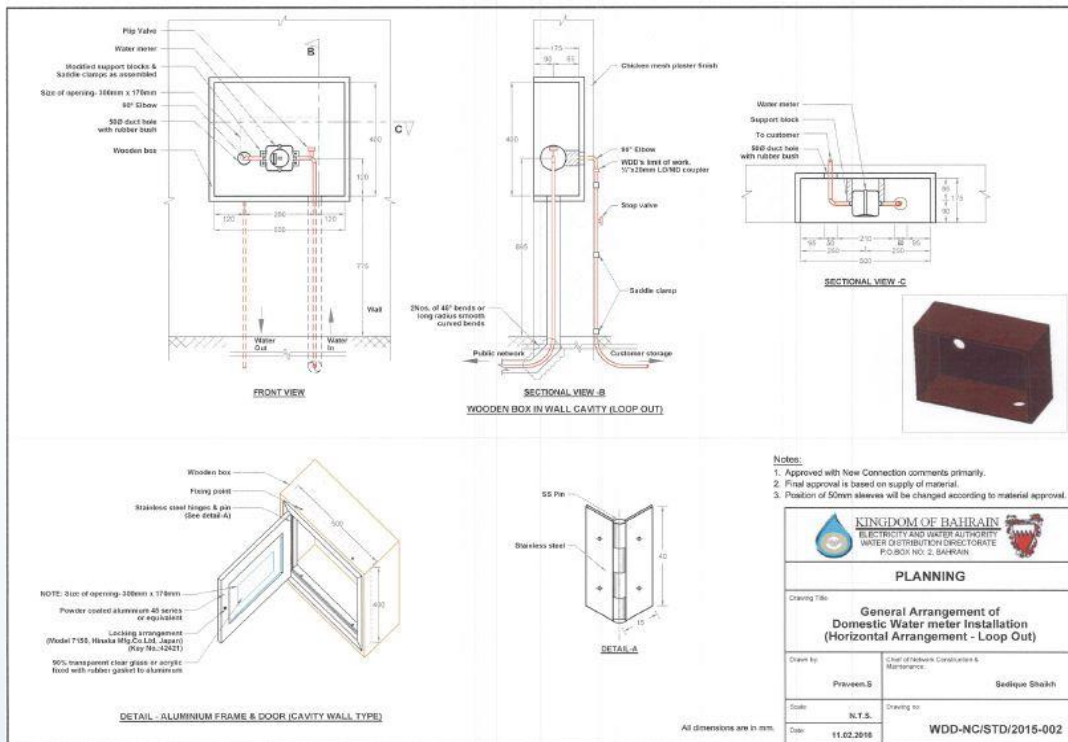

Figure 1. Cavity Loop-Out (Horizontal Arrangement)



Figure 2 : Cavity Loop-out

B. Cavity Loop-In

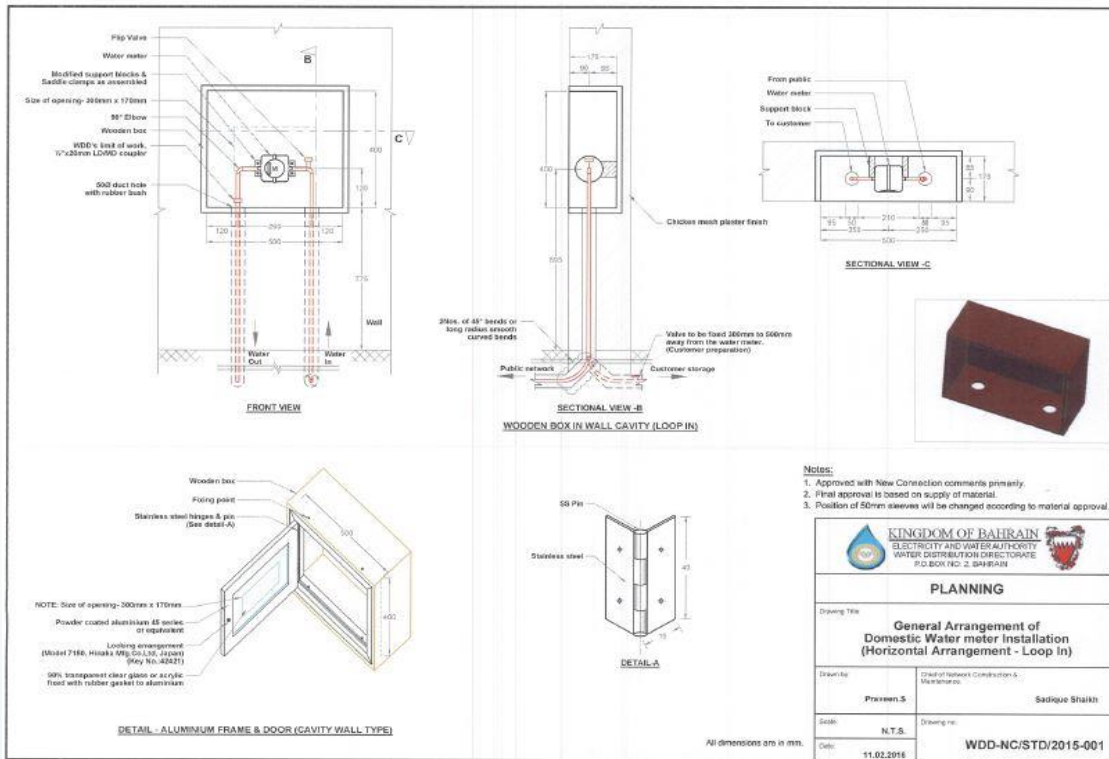

Figure 3. Cavity Loop-In (Horizontal Arrangement)



Figure 4. cavity Loop-in

2.2. Premises without Boundary Wall

- Wall mounted water meter type to be installed on the premise structure as shown in Figure5.
- The meter to be installed on the side wall with a maximum distance of (60cm) from the property line as shown in Figure6.



Figure 5. Wall Mounted Water Meter



Figure 6. Wall Mounted Water Meter on Side Wall

2.3. Compound with Boundary Walls (Gated)

1. Manifold type to be installed on external boundary wall.
2. The customer has to lay the internal pipes to the manifold box as shown in figures 7 & 8.
3. Each unit must be provided with proper storage independently.
4. The maximum distance between the ground tank and the meter is not more than (30m).
5. The size of manifold depends on the number of units, either (25mm) or (50mm) for 10 meters.
6. The table below shows number of meters that can be installed in manifold system and size of main pipe.

Size of main pipe	No. of units can be supplied
25 mm	5 units
50 mm	10 units



Figure 7. (50mm) manifold



Figure 8. (25mm) manifold

2.4. Residential / Commercial Premises

This category includes all buildings that consist of flats with/without shops within the same premise. The arrangements for these buildings must have individual water meters connected through one main meter.

- No separate tapping will be provided for the shops in case of the customer has requested in future. Therefore, the customer has to design it in the initial plumbing drawings as a provision for service connection in the meter box.
- The Cavity meter or Wall Mounted meter type to be selected and installed for buildings with 5 units or less with (15mm) service connection.
- The Ground meter type to be selected and installed for buildings with 6 to 30 units with (25mm) service connection, figure 9.
- The Ground meter type to be selected and installed for buildings with more than 30 units with (50mm) service connection, figure 10.

The table below shows the sizes of service connections relevant to the number of units in each building and the installation methods:

Size of connection	No. of units	Installation method
½"	0 – 5	Wall
1"	6 – 30	Ground
2"	30 or more	Ground

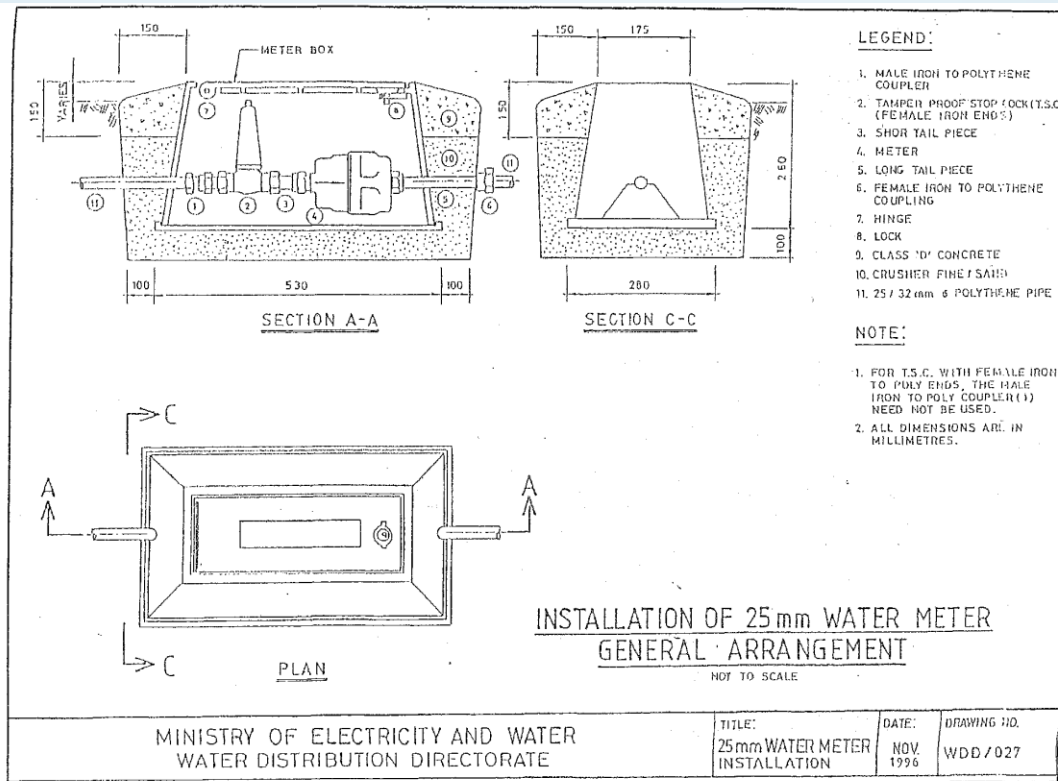

Figure 9. (25mm) Ground Meter Size For 6 to 30 Units

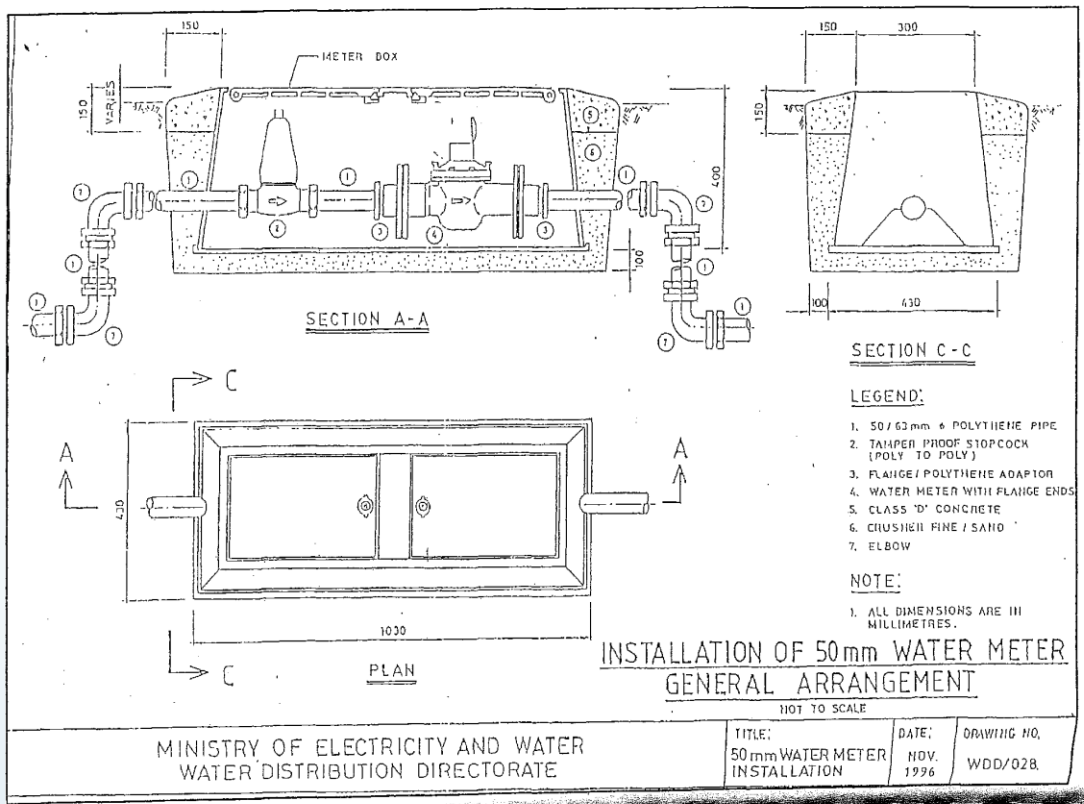
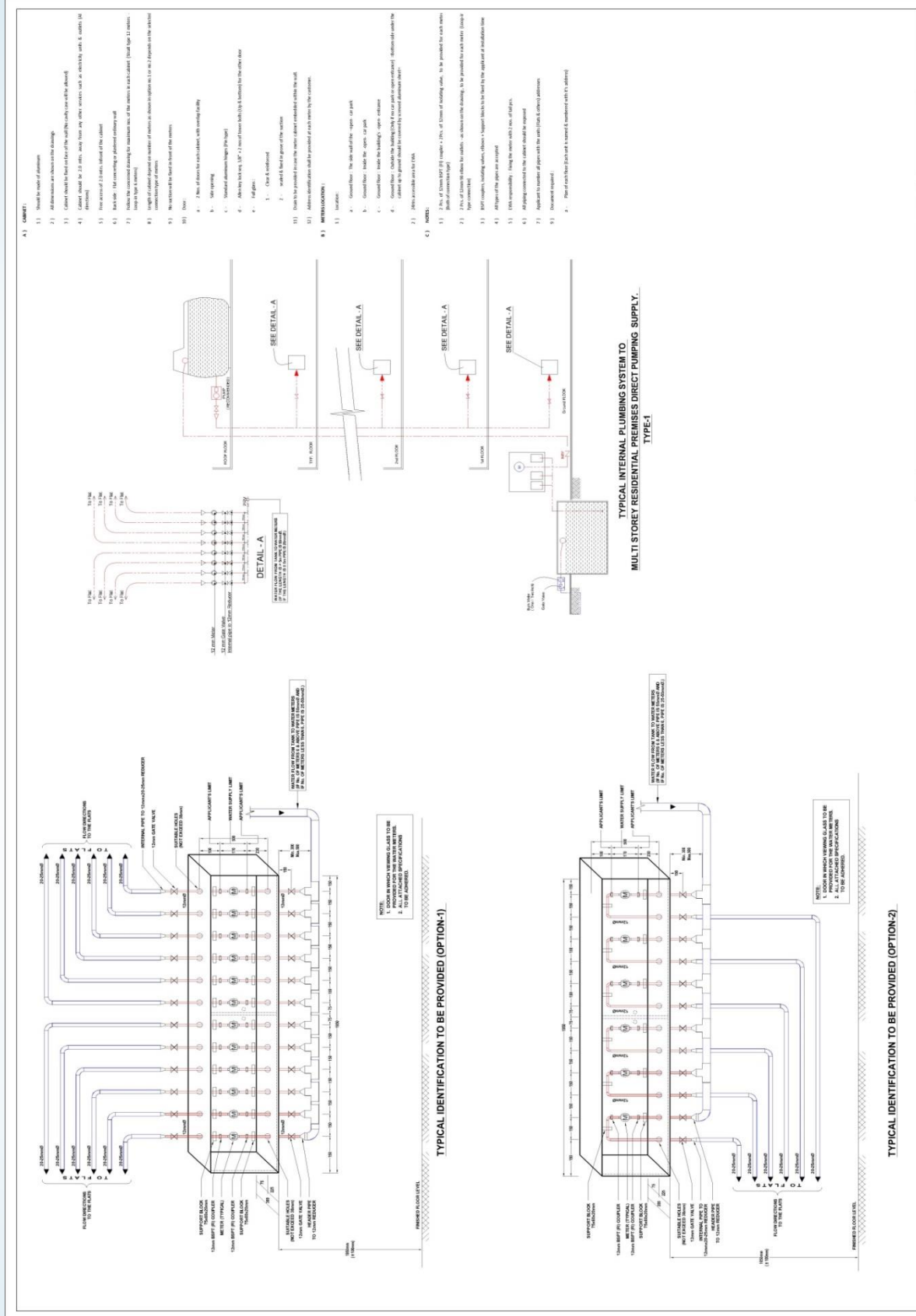

Figure 10. (50mm) Ground Meter Size For More Than 30 Units

Requirements for Individual Meter Installation:

- Individual meters must be installed in an aluminium box that is located in an accessible area as approved in the building permit. The dimensions for the water meter box is shown in figures 11 and 12.
- The height of the wall mounted meters should be between (1.2m – 1.5m), which is at eye-sight level.
- The individual meters must be in line with (150mm), centre to centre clearance, as shown in figures 11 and 12.
- The customer is responsible to provide two isolating valves for upstream and downstream at each individual meter.
- Each supply pipe must be clearly tagged with the unit number of each (unit/flats/shops).
- The main supply pipe size to the individual meter shall be (25mm) for 5 units and (50mm) for more than 5 units.
- Two female couplers threaded type of size $\frac{3}{4}$ " to be provided by the customer at gap spacing as instructed by WDD site inspector.
- Individual meter box must be located in the ground floor as illustrated in figure 11.
- For high-rise buildings, the individual meter box shall be located at each floor. (Refer to figure 12).



	DRAWING NO: WDD-01
KINGDOM OF BAHRAIN	DRAWN BY: Firas Al-Sayid
ELECTRICITY AND WATER AUTHORITY	CHECKED BY: S. Hussain
WATER DISTRIBUTION DIRECTORATE	APPROVED BY: Fawaz Al-D
P.O. BOX NO. 2, BAHRAIN	DATE: 14-03-2013

Figure 11

2.5. Commercial Premises

For the buildings with shops only and without entrance address card, the manifold arrangements to be selected.

2.6. Bulk Customer

- Commercial malls , hotels , factories , hospitals, clubs, etc. shall be supplied with one bulk meter.
- The size of the meter will be decided based on the daily water demand as detailed in the attached table 1 below.



Water Distribution Directorate

Water Demand Form

Engineering Office

Project

Address

No	Type	Liters/day	Units	Total	Remarks
1	Villa				
2	Flat				
3	Working staff	35			Per staff (6 to 8 hours working offices)
4	Visitors in Offices	5			If visitors are spending (1-2) hours
5	Students in schools	15			Per Student
6	Students in Technical Schools	20			Per Student
7	Hostel	180			Per Student
8	Hospital	455			Including working staff & other usage in the hospital.
9	Visitors in health center	10			If visitors are spending more than 2 hours
10	Labour Camp	180			Per Person
11	Hotel	275			Including kitchen use & cleaning.
12	Car Wash	100			Each car
13	Laundry for washing	10			Per kilogram (Cloth)
14	Cattle-Livestock	50-100			Per Head
15	Industrial use				For factories
16	Restaurant	50			Per sqm

Engineer name:

Signature:

date:

Stamp:

WDD – WS 1 APRIL 2015

Table 1

2.7. Storage capacities

- Customer must provide sufficient storage capacity for three days consumption demand.
- The storage capacity must be distributed between ground and roof tanks. Ground tank to have twice the storage capacity of the roof tank. Example – a villa requiring total storage capacity of six cubic meters (6m^3) should have the following arrangement: Ground tank of four cubic meter (4m^3) and Roof tank of two cubic meter (2m^3), as illustrated in figure 13.

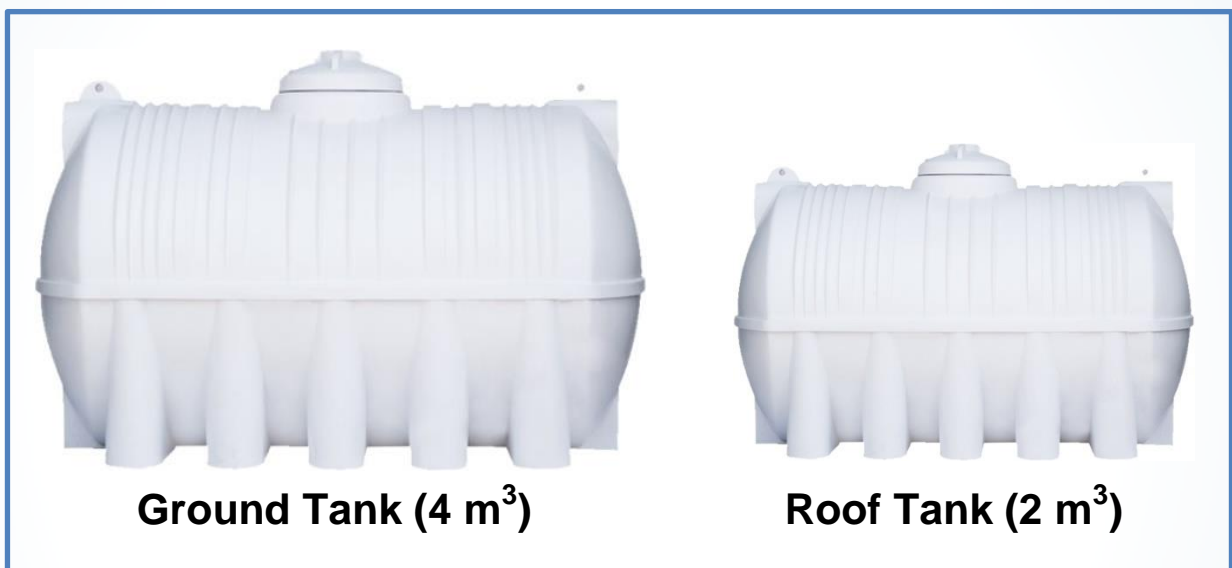

Figure 13

- For flats, the storage capacity is estimated as 4 cubic meters each unit.

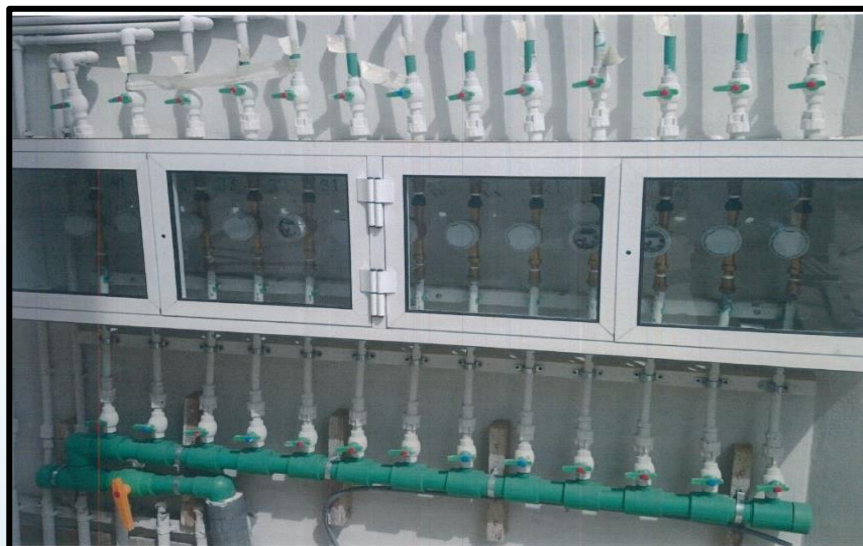

Figure 14

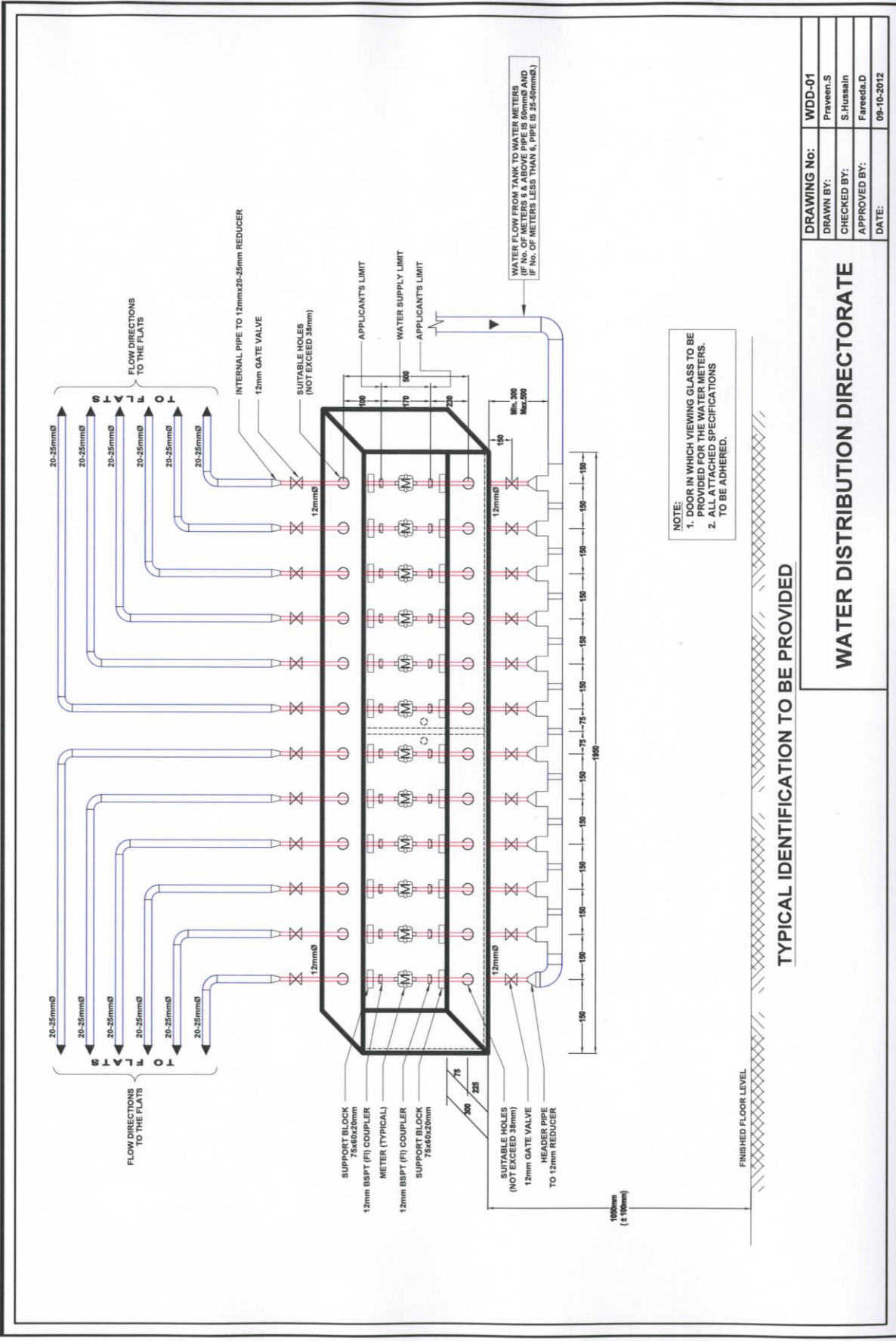

Figure 15

Contacts

Electricity and Water Conservation Directorate

Water Conservation Section:

Office Engineers:	1799 1485	3605 3099
	1799 1519	3605 6670

Site Inspectors:	1799 1483	3605 3191
	1799 1482	3605 3043
	1799 1526	3369 7040

For further inquiries please do not hesitate to contact us on:

Fax: 17006427

Email: water.conservation@ewa.bh

Web-site: www.ewa.bh



Toll-Free: 80008002

Water Distribution Directorate:

General Inquiries:	1799 1626	1799 7650
--------------------	-----------	-----------

Site Inspectors:	Area 1&2 (Muharraq)	3605 2099
	Area 3 (Manama)	3605 4489
	Area 4&5 (Seef & Jidhafs)	3605 2457
	Area 6&7 (Budaya Road)	3605 2459
	Area 8&9 (Riffa & Isa Town)	3605 2584
	Area 10&12 (Hamad Town)	3605 2460



Emergency Contact: 17515555

